

ATS 420 ATS CONTROLLER USER MANUAL



Software Version

No.	Version	Date	Note
1	V1.0	2021-07-01	Original release.



Chongqing Mebay Technology Co.,Ltd

Add: No6-2,Building 4, Gangan Rd, Jiangbei District, Chongqing.

Tel: +86-23-6869 3061



Fax: +86-23-6765 8207

Web: <http://www.mebay.cn>

<http://www.cqmb.cn>

E_mail: sales@mebay.cn

Symbol Description

Symbol	Description
 Note	Remind operators to operate correctly, otherwise it may cause the equipment not to work correctly.
 Be care	It is indicated that potential hazards can damage equipment without proper precautions.
 Warning	It is indicated if appropriate preventive measures are not taken, potentially dangerous situations may result in death, serious personal injury or significant property losses.

**Warning**

- 1.The installation of this equipment must be carried out by professionals.
- 2.When installing and operating the controller, please read the entire instruction manual first.
- 3.Any maintenance and commissioning of the equipment must be familiar with all the equipment.
- 4.Safety standards and precautions in advance, otherwise it may cause personal injury or damage to related equipment.
- 5.After the installation of the controller is completed, please verify that all protection functions are valid.

**Be Care**

- 1.Please keep the good connection of the power supply of the controller. Do not share the connection lines of the positive and negative electrodes of the battery with the floating charger.
- 2.During the operation of the engine, do not disconnect the battery, otherwise it may cause damage to the controller.

Catalogue

Summary 6

Main Features 6

Parameters Display 7

Parameters 7

Overall Dimension and Wiring Diagram 8

Installation instruction 14

Panel and display 15

Generator set start/stop operation 16

Switch operation and ATS power control 19

Prompt status information 20

Parameter setting 22

Fault finding 28

Notes:

1. All rights reserved. No part of this duplication may be reproduced in any material form (including photocopying or storing in any medium by electronic means or others) without the written permission of the copyright holder.
2. MEBAY Technology reserves the rights to change the contents of this document without prior notice.

Summary

The controller is a dual power switching ATS controller, dual power intelligent switch module with programmable, automatic measurement, automatic control and LCD display functions. Automatic measurement and control can reduce incorrect operation. It is an ideal option for ATS.

2.8inch LCD screen display with brand new UI design is adapted in this controller can display related parameters directly. The LCD screen can display various faults at the same time. Once the generator does not run normally, it can effectively achieve protection.

There are Chinese/English interface options, more language can be set according to user's request. All the parameters can be configured through the front face buttons or use programmable interface by RS485 or USB to adjust via PC. It has compact structure, advanced circuits, simple wiring and high reliability, It can be widely used in various types of power systems.

Main Features

There are two Models under ATS 420 series.

ATS 420: Dual power intelligent switch module.

ATS 420 R: Based on ATS 420, it adds RS485 port.

- ◆ 32bit high performance single chip microcomputer.
- ◆ 2.8inch LCD screen, Available in Chinese/English languages, user's language set if necessary.
- ◆ System type can set as: "S1 Mains S2 Mains", "S1 Mains, S2 Gen", "S1 Gen S2 Mains", "S1 GenS2 Gen".
- ◆ Acrylic material is adapted to protect the screen.
- ◆ PC material panel, waterproof, oil-proof, UV-resistant, good operation feel and long service life.
- ◆ USB Port: parameters can be set even without power through USB port to monitor in real time.
- ◆ With RS485 communication port, can achieve "Three Remote" functions via MODBUS protocol.
- ◆ Collection and display, gen, mains, power, phase and other parameters.
- ◆ Applicable for PC Three-stage, PC Two-stage, CB and CC switch.
- ◆ Automatic/Manual mode. In manual mode, can force the switch to close or open.
- ◆ Can control two generators to work as Cycle Run mode, Master Run mode and Balance Run mode.
- ◆ Suitable for various AC systems (3 phase 4-wires, 3-phase 3-wires, single-phase 2-wire, and 2-phase 3-wire).
- ◆ Input/output function, status can be shown directly.
- ◆ Real time clock inside.
- ◆ Totally 5 relays output, 3 relays function configurable.
- ◆ Totally 4 configurable switch input, 2 switch function configurable.
- ◆ Control Protection: Realize automatic ATS switching of generator sets, perfect fault display and protection functions.

- ◆ Standard water-proof rubber gasket. The waterproof can reach IP65.
- ◆ Module design: All the connections are adapted with European connectors so that installation, connection, repair and replacement can be more easily.

Parameters Display

- ◆ S1/S2 Voltage status
- ◆ S1/S2 Frequency
- ◆ Current real-time status
- ◆ S1/S2 Switch status
- ◆ S1/S2 Phase voltage
- ◆ S1/S2 Work status
- ◆ Input/Output status
- ◆ Total Power-on time
- ◆ Alarm number and account
- ◆ Alarm type (Warn Alarm, Fault Alarm)
- ◆ Alarm event
- ◆ Inputs, outputs number
- ◆ Input status, S1/S2 closing input, 1~2 are configurable ports
- ◆ Output status, S1/S2 closing output, 1~3 are configurable ports
- ◆ Real-time clock
- ◆ Current date/time

Parameters

Options	Parameters
Working voltage	DC 8V----36V Continuous
Power consumption	Standby: 24V: MAX 2W
	Working: 24V: MAX 3W
S1 AC Voltage Input	1P2W 30VAC-360VAC (ph-N)
	2P3W 30VAC-360VAC (ph-N)
	3P3W 60VAC-620VAC (L-L)
	3P4W 30VAC-360VAC (ph-N)
S2 AC Voltage Input	1P2W 30VAC-360VAC (ph-N)
	2P3W 30VAC-360VAC (ph-N)
	3P3W 60VAC-620VAC (L-L)
	3P4W 30VAC-360VAC (ph-N)
MAX Accumulating Time	99999.9Hours (Min Store time:6min)
Closing S1 output	250V/10 AMP Non-contact normally Open output

Closing S2 output	250V/10 AMP Non-contact normally Open output
AUX. OUTPUT 1	250V/5 AMP Non-contact normally Open/Close output
AUX. OUTPUT 2/3	250V/10 AMP Non-contact normally Open/Close output
Closing S1 input	Available if connecting with Battery -
Closing S2 input	Available if connecting with Battery -
AUX.INPUT 1/2	Available if connecting with Battery -
Working condition	-25-65°C
Storage condition	-40-85°C
Protection Level	IP65: when waterproof rubber gasket is added between controller and its panel
Insulation strength	Apply AC 2.2kV voltage between high voltage terminal and low voltage terminal; The leakage current is not more than 3mA within 1min.
Overall dimension	142mm*105mm*45mm
Panel cutout	116*90mm
Weight	0.5Kg

Overall Dimension and Wiring Diagram

◆ Overall Dimension:



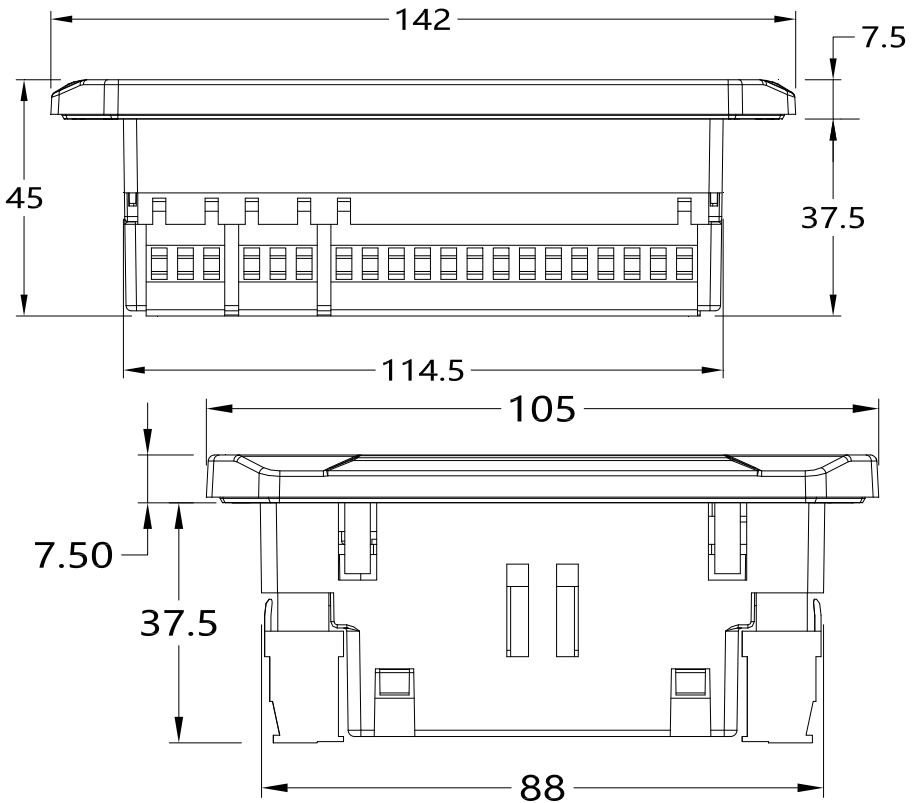

◆ Descriptions of terminal connection

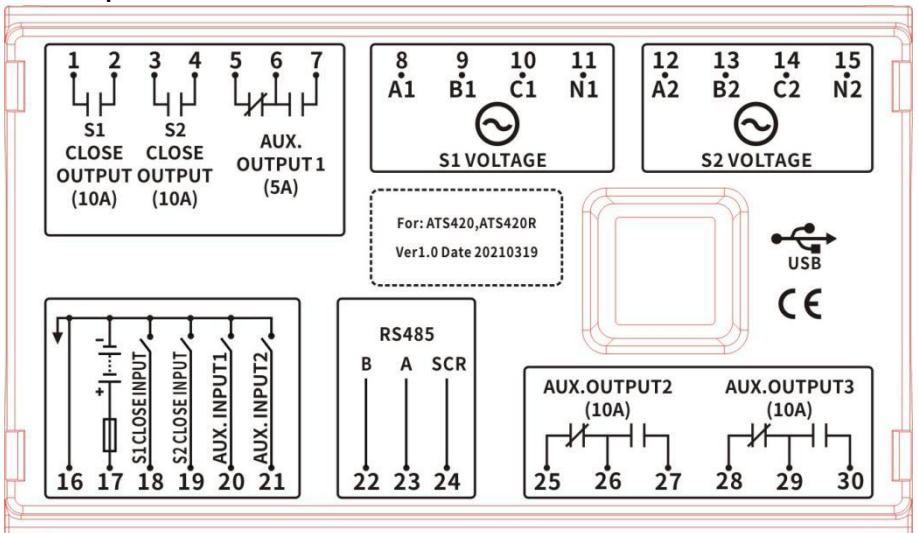

No.	Function		Description	Cable cross sectional area
1	S1 Close Output		Non-contact normally Open output	1.5mm ²
2			Capacity: 250V/10A	1.5mm ²
3	S2 Close Output		Non-contact normally Open output	1.5mm ²
4			Capacity: 250V/10A	1.5mm ²
5	Aux. Output 1	Normally Close	250V/5 AMP Relay contact Output	1.5mm ²
6		COM		1.5mm ²
7		Normally Open		1.5mm ²
8	A1		S1 AC System 3P4W voltage input For single phase, only connect A1, N1	1.5mm ²
9	B1			1.5mm ²
10	C1			1.5mm ²
11	N1			1.5mm ²
12	A2		S2 AC System 3P4W voltage input For single phase, only connect A2, N2	1.5mm ²
13	B2			1.5mm ²
14	C2			1.5mm ²
15	N2			1.5mm ²
16	B-		Connected with negative of starter battery.	1.5mm ²
17	B+		Connected with positive of starter battery.	1.5mm ²
18	S1 Close Output		Detect the S1 ATS closing status, Ground connected is active.	1.5mm ²
19	S2 Close Output		Detect the S2 ATS closing status, Ground connected is active.	1.5mm ²
20	Aux. Input 1		User-defined.	1.5mm ²
21	Aux. Input 2		Ground connected is active.	1.5mm ²
22	RS485_B-		RS485 Communication Port A 120 Ω shielded wire and good grounding are recommended	1.0mm ²
23	RS485_A+			1.0mm ²
24	RS485_SCR			1.0mm ²
25	Aux. Output 2	Normally Close	Default: ATS Power L 250V/10AMP Relay contact Output	1.5mm ²
26		COM		1.5mm ²
27		Normally Open		1.5mm ²
28	Aux. Output 3	Normally Close	Default: ATS Power N 250V/10AMP Relay contact Output	1.5mm ²
29		COM		1.5mm ²
30		Normally Open		1.5mm ²
	USB-B		For PC operation and control	

◆ **ATS 420 Typical Wiring Diagram**

⚠ The following is a full-function application diagram of the ATS controller series. The AUX. OUTPUT1 is set as the gens start output (normally open) of the default.

◆ **MBS1 Wiring Diagram**

Parameters Setting		
1	Switch Type	PC Three-stage
2	Aux. Output 1	Gen Start Output
3	Aux. Output 2	ATS Power L
4	Aux. Output 3	ATS Power N

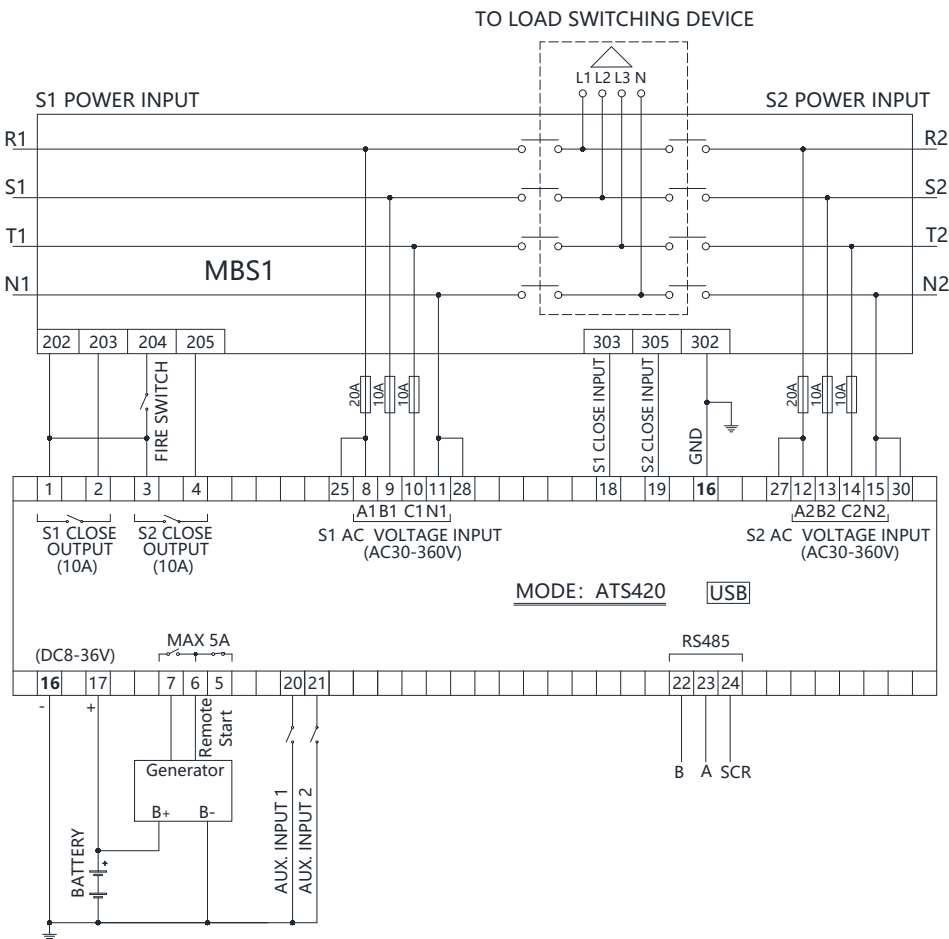

◆ Contactor Wiring Diagram

Parameters Setting		
1	Switch Type	CB/CC
2	Aux. Output 1	Gen Start Output
3	Continuously Close	1-Enable

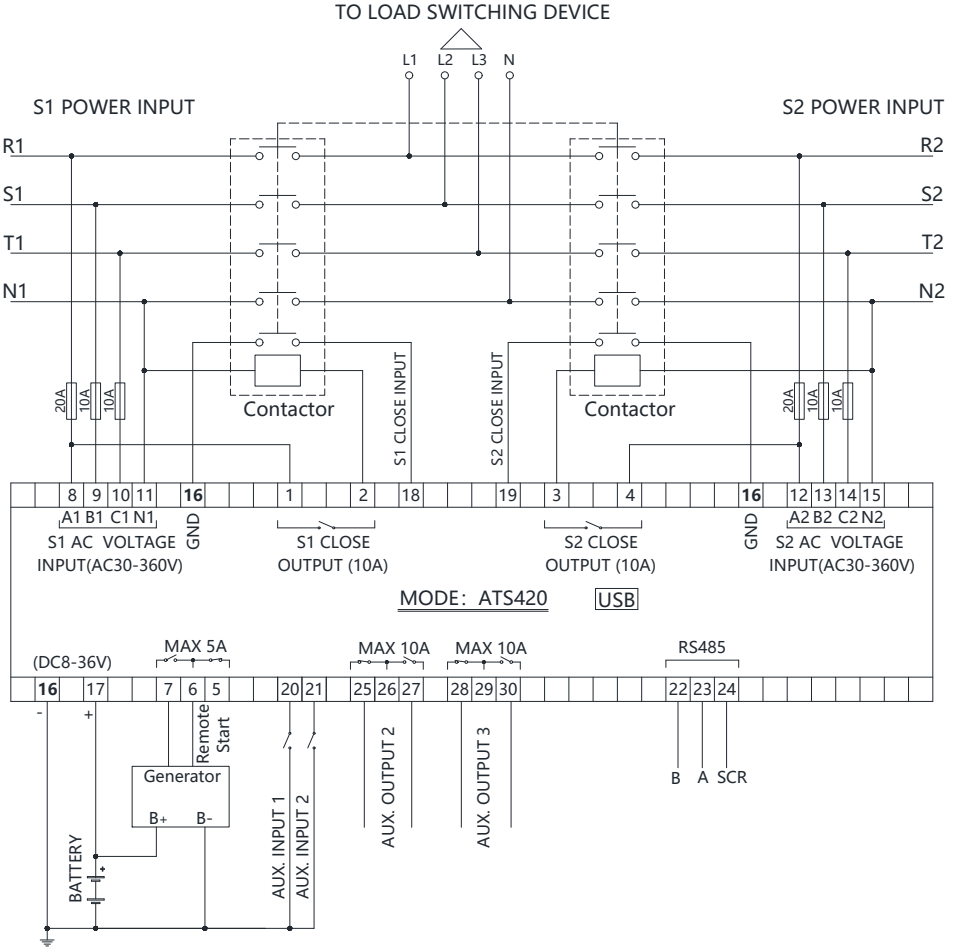

◆ Breaker Wiring Diagram

Parameters Setting		
1	Switch Type	CB/CC
2	Aux. Output 2	S1 Open Control
3	Aux. Output 3	S2 Open Control
4	Aux. Output 1	Gen Start Output
5	MCH:Stored Energy Motor; MN:Under Voltage Trip; MX:Open Relay;XF:Close Relay;	

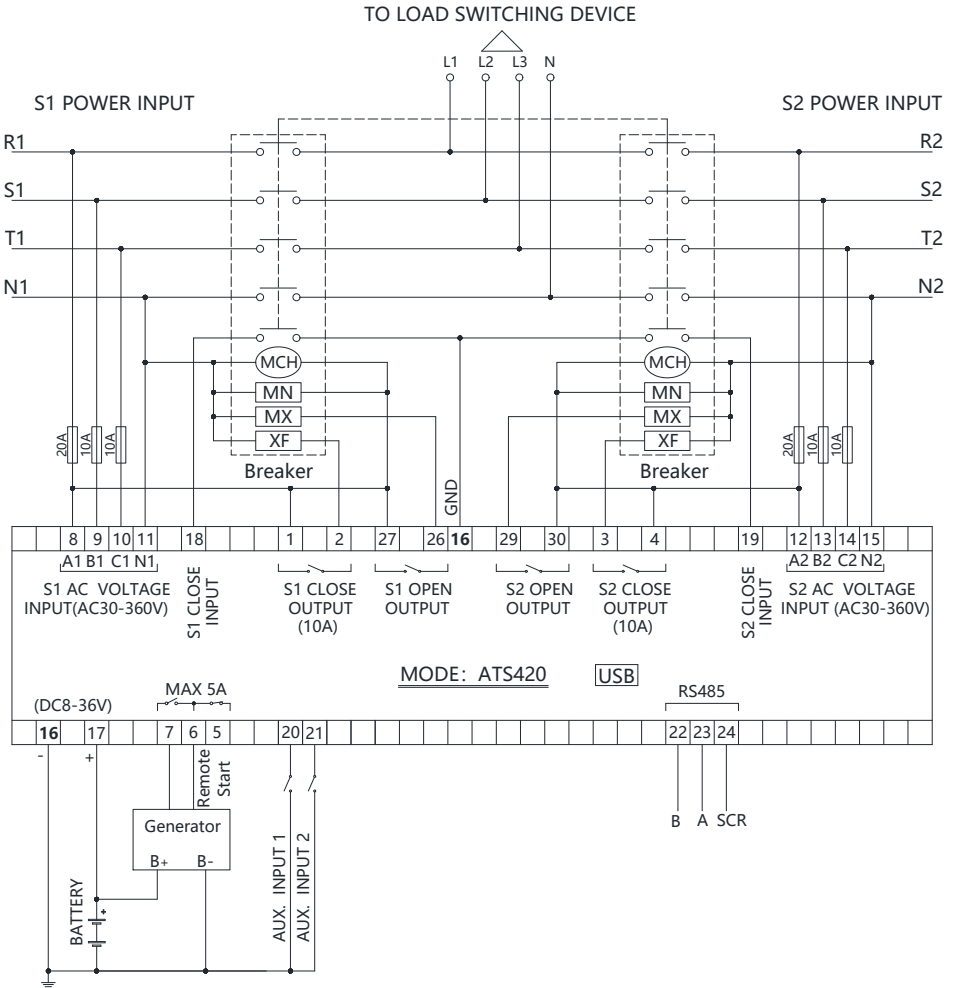

Installation instruction

- ◆ The controller is fixed by two special fixing members and screws, and the screws of the metal fasteners cannot be too tight.
- ◆ Panel Cutout: W116mm*H90mm.

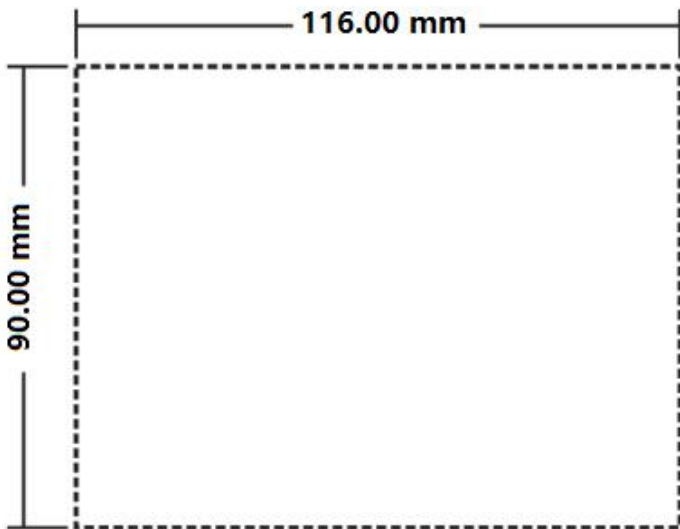

Note: If the controller is installed directly in the genset shell or other fluctuated equipment, the rubber pad must be installed.

◆ **Battery Voltage Input**

ATS 420 controller is suitable for 8-36V DC battery voltage. Battery negative must be reliably connected to the enclosure of the engine. The controller power supply B+ and B- must be connected to battery positive and negative, and the wire size must not be less than **1.5mm²**.



NOTE:

In case of floating charger connect charger output to battery positive and negative directly, then, connect battery positive and negative poles to controller positive and negative power supply.

◆ **Output and relay expansion**



Note: All outputs of the controller are relay contacts. The maximum current capacity is described in the "Parameters" in this manual. Please use it in the relay current capacity. If an extended relay is needed, add a continuous current diode (when the extended relay coil is DC) or a resistance-capacitance loop (when the extended relay coil is AC) to both ends of the coil to prevent interference with the controller or other equipment.



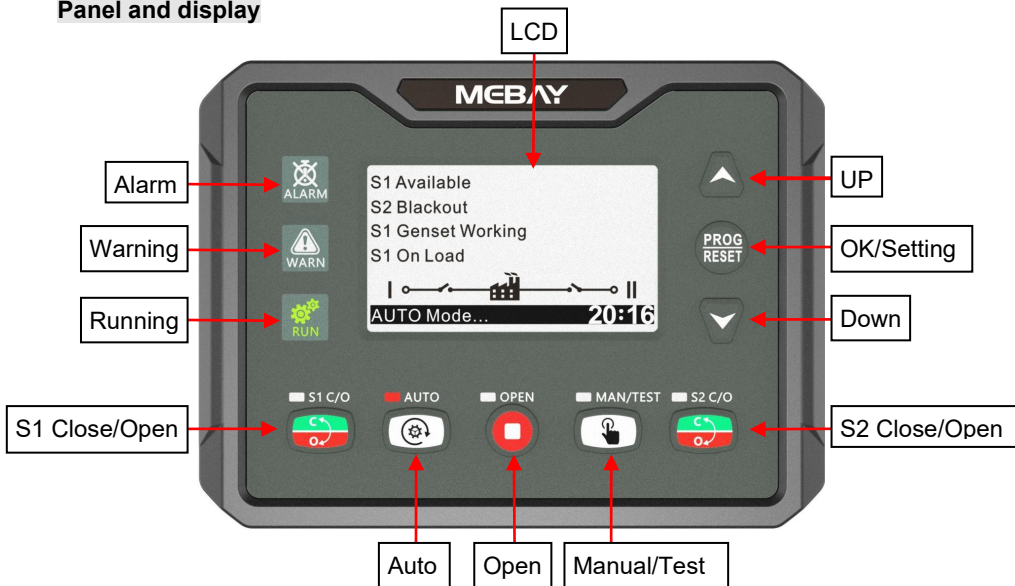

If withstanding voltage test is conducted after the controller has already been installed onto the control panel, please unplug all controller terminal connections in order to prevent high voltage from damaging it.

Panel and display



◆ Key Function Description

KEYS	NAME	Main Function
	Open	<ul style="list-style-type: none"> ◆ Under running status. Press this key to stop the generator set and operate all partial brakes; ◆ Pressing this key can cancel the setting and back to upper class under edition. ◆ Under the setting mode with checking data, the data can be saved and system will exit after pressing.
	Manual Test	<ul style="list-style-type: none"> ◆ Pressing this key will set the module into manual mode. ◆ On manual mode press this key enter into genset manual start/stop operation interface.
	Auto	<ul style="list-style-type: none"> ◆ Pressing this key will set the module into auto mode.
	S1 Close/Open	<ul style="list-style-type: none"> ◆ Active in Manual mode. Press this key, if S1 load is opened, then the S1 closing relay will be energized; if S1 load is closed, then the S1 opening relay will be energized.
	S2 Close/Open	<ul style="list-style-type: none"> ◆ Active in Manual mode. Press this key, if S2 load is opened, then the S2 closing relay will be energized; if S1 load is closed, then the S2 opening relay will be energized.
	Up	<ul style="list-style-type: none"> ◆ Under display mode, parts of the page can move up. ◆ Under edition mode, pressing this key to move the digit or increase the numbers.









	Down	<ul style="list-style-type: none"> ◆ Under records mode, pressing this key to move the digit. ◆ Under display mode, parts of the page can move down. ◆ Under edition mode, pressing this key to move the digit or decrease the numbers. ◆ Under records mode, pressing this key to move the digit.
	OK SET Eliminate alarm	<ul style="list-style-type: none"> ◆ Confirm the change under edition mode. ◆ Shift right under edition mode. ◆ Page exited under records checking mode. ◆ In standby state, press for 3 seconds to enter the parameter setting mode. ◆ In the alarm page, press this key to eliminate the fault alarm.

◆ LED Indicators description

Indicator Type	Description
Alarm	◆ Lights red when a fault alarm occurs.
Warning	◆ Lights yellow when a warning alert occurs.
Running	◆ Green during normal operation.
S1 Close Status	◆ It is light on when S1 close input is activated.
S2 Close Status	◆ It is light on when S2 close input is activated.
Manual/Test Mode	<ul style="list-style-type: none"> ◆ It is light on when the module is in Manual mode. ◆ It is light on when the module is in Test mode.
Auto Mode	◆ It is light on when the module is in Auto mode.

◆ Alarm records checking



ATS 420 controller can save 14 group of alarm records which contains the alarm record data includes detailed data such as alarm time, prompt status information, etc. How to check the alarm records:

1. Enter alarm record page: Enter the setting mode, select the alarm record and press  key to enter
2. Press  to turn upper digit and press  to turn lower digit in order to choose the record you need. Press  to confirm the record and come into history records checking page.
3. Press  to turn lower records under records checking page. Press  to turn upper records and press  to revert back to alarm history records page.
4. Exit from records page: In the history records page and checking page, press  to exit.

Generator set start/stop operation

Test machine

In the main screen on manual mode, press  key will enter into manual start operation interface.

Press / key to choose parameters (the current line was highlighted with black) and then press Confirm key to confirm.

1.Return	
2.Stop Genset	Disconnect the start signal, i.e. stop the running genset.
3.Start Genset	Output the start signal, i.e. start the genset.

When system is "S1 Gen S2 Gen", manual start/stop menu interface is as follows:

Press / key to choose parameters (the current line was highlighted with black) and then press Confirm key to confirm.

1.Return	
2.S1Stop Genset	Disconnect the S1 start signal, i.e. stop the running S1 genset.
3.S2 Start Genset	Output the S1 start signal, i.e. start the S1 genset.
4.S1Stop Genset	Disconnect the S2 start signal, i.e. stop the running S2 genset.
5.S2 Start Genset	Output the S2 start signal, i.e. start the S2 genset.

Manual start

Press and manual mode indicator is on, which means controller is in manual mode.

Press , S1 close relay outputs immediately, if S1 close input is active, the S1 power supply connects to load.

Press , S2 close relay outputs immediately, if S2 close input is active, the S2 power supply connects to load.

Press , S1/S2 open relay outputs immediately, if S1/S2 close input is inactive, the S1/S2 power supply disconnects with load.

NOTE: For the ATS without neutral position, it is invalid to press key.

Remote start/stop

Send remote start/stop signals using MODBUS protocol via RS485 port.

Remote Stop: Disconnect the start signal, i.e. stop the running genset.

Remote Start: Output the start signal, i.e. start the genset.

Auto start/stop

Input port start/stop operation

Set input port as "Remote Start On Load" or "Remote Start Off Load", both could not be set simultaneously.

Remote Start on Load: When the input is active, genset close relay will active after genset is normal; when the input inactive, genset will stop automatically.

Remote Start off Load: When the input is active, mains close relay will active after mains is normal; genset close relay will active when the mains is abnormal while genset is normal; when the input inactive, genset will stop automatically.

"S1 GEN S2 GEN" start/Stop

When system is "S1 Gen S2 Gen", input port start/stop function is as follows:

Remote Start on Load: Detect S1 or S2 start output according to start mode. Genset close relay will active after genset is normal.

Remote Start off Load: Detect S1 or S2 start output according to start mode. Both genset S1 close relay and S2 close relay are deactivated after genset start.

S1,S2 Gens Start Type: Cyps Run, Master Run, Balance Run.

Cycle Run Start:

When remote start is active, S1 and S2 cycle run start according to the cycle run time. At the first time to start the genset, choose "S1 Start" or "S2 Start" depends on the "Master Set" information. e.g. S1 start at the first time if "S1 Master" is selected. The S1 cycle run countdown is started according to the preset delay. At the same time, genset fault delay will be initiated. If S1 genset is normal before the fault delay has expired, S1 will take load; S2 start after the preset S1 cycle run delay has expired and the S2 loading process is same as S1. S1 will stop automatically after the S2 has take load successfully. S1 and S2 will cycle run in this way alternately until the remote start signal deactivated.

During the start process, if there is genset fault alarm (genset fault delay overtime or genset fault input is active), fail to close or load inhibit alarm occurs, the starting genset will be stop immediately and the additional genset will be start automatically. During the cycle run process, if "Auto Mode" is selected, the current status will be hold and the "cycle run countdown" will be suspended.

Master Run

Mater genset will be start when remote start signal is active. During the start process, if there is genset fault alarm (genset supply delay overtime or genset fault input is active), fail to close or load inhibit alarm occurs, the starting genset will be stop immediately and the additional genset will be start automatically. Otherwise, the master run genset will running continuously until the remote start signal deactivated.

Balance Run

The gensets which has the shortest running hours will be start when remote start signal is active. During the start process, if there is genset fault alarm (genset supply delay overtime or genset fault input is active), fail to close or load inhibit alarm occurs, the starting genset will be stop immediately and the additional genset will be start automatically. Otherwise, the current genset will running continuously until the remote start signal deactivated.

In system "S1 Gen S2 Gen" to start/stop genset should meet following several conditions:



- 1) It is active in Auto mode;
- 2) System set as "S1 Gen S2 Gen";
- 3) Output port should be set as "S1 Genset Start" and "S2 Genset Start" ;
- 4) Input port should be set as "S1 Genset Fault Input", "S1 Genset Fault Input" and "Remote Start On Load" or "Remote Start Off Load";



- 5) Should set start mode when "S1 Gen S2 Gen" system is selected;
- 6) Should configure setting "Genset Supply Delay", If start mode is cycle run, also should set "S1 Cycls Run Time" and "S2 Cycls Run Time";

 Among input ports, "S1 Genset Fault Input" and "S2 Genset Fault Input" are selective setting, Genset fault can be judged by "Genset Supply Delay" and there no need to inquire the fault alarm via input port. When S1, S2 start type configured as "Not Used", there is no start genset signals output

Switch operation and ATS power control

Manual mode is selected by pressing the  button; a LED besides the button will illuminate to confirm the operation.

Press S1  button, S1 close relay will active, after the close delay has expired, S1 close relay will deactivated and the S1 take load. Press S1  button again (Invalid for the ATS without Open Control), S1 open relay will active, after the open delay has expired, S1 open relay will deactivated and the S1 off load.

Press S2  button, S2 close relay will active, after the close delay has expired, S2 close relay will deactivated and the S2 take load. Press S2  button again (Invalid for the ATS without Open Control), S2 open relay will active, after the open delay has expired, S2 open relay will deactivated and the S2 off load.

Automatic operation

Auto mode is selected by pressing the  button; a LED besides the button will illuminate to confirm the operation. The controller will select S1 power or S2 power according to the preset "master set" and control the genset to start according to the preset conditions.

ATS Power supply

Switch Power Type can be set as DC Power or AC Power. If DC Power is selected, then the switch can be transferred at any time (even when both S1 and S2 are outage). If AC Power is selected, whether the power is normal or not should be judged according to the ATS power setting and AC power voltage.

The power of ATS is supplied by controller, as long as one power is normal, this can ensure ATS voltage power supply normally and can be transferred properly. Users should select power supply voltage (phase voltage or line voltage) based on ATS type. If choose phase voltage, connect the phase voltage of S1 and S2 (e.g. A phase) to normally close (Pin25) and normally open (Pin27) contact of auxiliary output 2; connect N phase of S1 and S2 to normally close (Pin28) and normally open (Pin30) contact of auxiliary output 3. And then connect the common output of auxiliary output 2 and auxiliary output 3 to ATS power supplies. Enter into the parameter setting interface, set the configurable output 2 as "ATS power L1" while set

the configurable output 3 as "ATS power N". If the ATS power supplied by Line Voltage, same procedures as above but change phase N to phase voltage and the auxiliary output 3 should be configured according to the set. Wiring diagrams are shown as following:

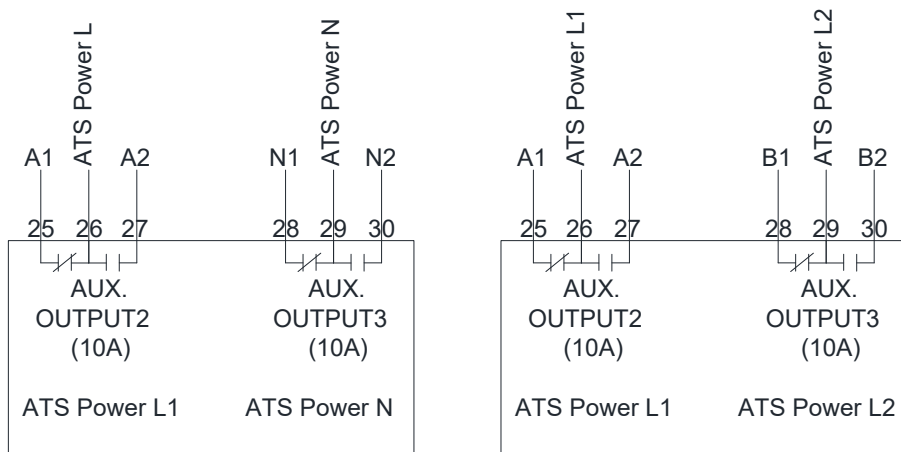

Prompt status information



The following is the prompt information and status display, also including warning/alarm status.

NO.	Item	Description
1	Please reset the alarm	When there is fault alarm occurs, the indication will be displayed when change the genset mode to Auto Mode manually. Show in status bar
2	S1 was already closed	After S1 was already closed, the indication will be displayed when "S2 close" button is pressed. Show in status bar
3	S2 was already closed	After S2 was already closed, the indication will be displayed when "S1 close" button is pressed. Show in status bar
4	Cycle Gen Start Mode	Cycle Run Start Mode is active when "S1 Gens S2 Gens" system is active. Show in status bar
5	Balance Gen Hours Mode	Balance Run Start Mode is active when "S1 Gens S2 Gens" system is active. Show in status bar
6	Master-Slave Gen Start Mode	Master Run Start Mode is active when "S1 Gens S2 Gens" system is active. Show in status bar
7	Auto Mode	Current mode is Auto mode. Show in status bar
8	Manual Mode	Current mode is Manual mode. Show in status bar

S1 Status (Upper to Lower)

No.	Item	Description
1	S1 Genset Fault	If there is "S1 fail to start" failure occurs when "S1 Gens S2 Gens" system is selected, it will initiate a fault alarm. " ALARM " lights always on, displays " S1 Genset Fault " on the current fault screen.
2	S1 Fail to Close	In Auto mode, S1 close failure is occurs. " ALARM " lights always on, displays " S1 Failed to Close " on the current fault screen.
3	S1 Fail to Open	In Auto mode, S1 open failure is occurs. " ALARM " lights always on, displays " S1 Failed to Open " on the current fault screen.
4	S1 Over Voltage	Voltage is higher than the set value.
5	S1 Loss of Phase	Loss of any phase of A, B and C.
6	S1 Over Freq	Frequency is higher than the set value.
7	S1 Under Freq	Frequency has fallen below the set value.
8	S1 Under Volt	Voltage has fallen below the set value.
9	S1 Phase Seq Wrong	A-B-C phase sequence is wrong
10	S1 Volt Normal	The S1 voltage is within the specified setting range

S2 Status (Upper to Lower)

No.	Item	Description
1	S2 Genset Fault	If there is "S2 fail to start" failure occurs when "S1 Gens S2 Gens" system is selected, it will initiate a fault alarm. " ALARM " lights always on, displays " S2 Genset Fault " on the current fault screen.
2	S2 Fail to Close	In Auto mode, S2 close failure is occurs. " ALARM " lights always on, displays " S2 Failed to Close " on the current fault screen.
3	S2 Fail to Open	In Auto mode, S1 open failure is occurs. " ALARM " lights always on, displays " S2 Failed to Open " on the current fault screen.
4	S2 Over Voltage	Voltage is higher than the set value.
5	S2 Loss of Phase	Loss of any phase of A, B and C.
6	S2 Over Freq	Frequency is higher than the set value.
7	S2 Under Freq	Frequency has fallen below the set value.
8	S2 Under Volt	Voltage has fallen below the set value.
9	S2 Phase Seq Wrong	A-B-C phase sequence is wrong
10	S2 Volt Normal	The S2 voltage is within the specified setting range

Other status (Upper to Lower)

















No.	Item	Description
1	Switch Trip Alarm	it will initiate a fault alarm. when the input is active. " ALARM " lights always on, displays " Switch Trip Alarm " on the current fault screen.
2	Forced Open Fault	When the input is active and the action select "Fault", it will initiate a fault alarm, " ALARM " lights always on, displays " Forced Open Fault " on the current fault

		screen.
3	Gens start	Genset start signal output.
4	Remote Start	This input is active when start the genset circularly.
5	Battery Over Volt	When the input is active and the action select "Warn", " WARNING " lights always on, displays " Battery Over Volt " on the current fault screen.
6	Battery Under Volt	When the battery voltage has fallen below the pre-set value," WARNING " lights always on, displays " Battery Under Volt " on the current fault screen.



Parameter setting

◆ Enter the edition page

Please set the parameters according to below steps:

- 1) In the any status and there is no alarm, please press  for 3 seconds to enter the parameter setting mode. The default password is "07623".
- 2) Press  and add number 1, press  to reduce number 1, press  to turn the digit into right, press  once done. Then system comes into menu after confirmation of password setting. The screen will display error if password is wrong. The correct password should be put after pressing any button.
- 3) Press  to turn the digit into upper position, press  to turn the digit into lower position, press  to get into parameters setting page.
- 4) Press  to shift up the parameters, press  to shift down the parameters, press  to get into parameter changing page.
- 5) Press  to add number 1, press  to reduce number 1, press  to turn the digit into right, press  once done. If the parameters setting is in the valid setting range, then it can be saved, if not, it can not be saved.
- 6) Press  to save the parameters and exit from edition page.
- 7) Press  to revert back to last class if in any setting position.

 Revert back to default: put password "97011" when coming into parameters setting, then all the parameters can be set as defaults.

 Note: the data can't be saved if the user didn't press  to confirm the setting.

◆ Parameter list.

1) Basic setting

No	Parameter	Range (default)	Notes
0	Language	0-English 1- 简体中文	Language option.
1	S1 Available Delay	1-3600S(10S)	The delay from S1 voltage abnormal to normal.
2	S1 Unavailable Delay	1-3600S(5S)	The delay from S1 voltage normal to abnormal.

3	S2 Available Delay	1-3600S(10S)	The delay from S2 voltage abnormal to normal.
4	S2 Unavailable Delay	1-3600S(5S)	The delay from S2 voltage normal to abnormal.
5	Master-Slave Set	0: S1 Master 1: S2 Master 2: No Master	Main and backup generator selection
6	System Type Set	0: S1 Mains S2 Gen 1: S1 Gen S2 Mains 2: S1 Mains S2 Mains 3: S1 Gen S2 Gen	Select the system type of S1, S2.
7	AC System	0: Single Phase,2-Wire 1: 2-Phase,3-Wire 2: 3-Phase,3-Wire 3: 3-Phase,4-Wire	AC power supply mode for closing output.
8	Rated Voltage	0-600V (220V)	AC system rated voltage value, used to calculate the alarm value.
9	Over Volt Set Value	0-200%(120%)	AC system voltage upper limit. If the value is greater than the upper limit, it will be abnormal. It will be disabled when the maximum value is 200.
10	Over Voltage Return	0-200%(115%)	AC system voltage upper limit return value. If the value is less than the return value, it is normal; if the maximum value is 200, it is disabled.
11	Under Voltage Set Value	0-200%(80%)	AC system voltage lower limit. If it is less than the lower limit, it will be abnormal. It will be disabled when the maximum value is 0.
12	Under Voltage Return Value	0-200%(85%)	AC system voltage lower limit return value. It is normal when it is greater than the return value, and it is disabled when the maximum value is 0.
13	Rated Frequency	10-75HZ (50HZ)	AC system rated frequency value, used to calculate the alarm value.
14	Over Frequency Set Value	0-200%(110%)	Upper frequency limit. If the value is greater than the upper limit, it will be abnormal. It will be disabled when the maximum value is 200.
15	Over Frequency Return Value	0-200%(104%)	Frequency cap return value. Less than the return value is normal, and it is disabled when the maximum value is set to 200.
16	Under Frequency Set Value	0-200%(90%)	Lower frequency limit. If the value is less than the upper limit, it will be abnormal. It will be disabled when the minimum value is set to 0.
17	Under Frequency Return Value	0-200%(96%)	Frequency lower limit return value. It is normal when it is greater than the return value. Disabled when the

			minimum value is set to 0.
18	Phase Sequence Wrong	0: Disable 1: Enable	Phase sequence detection.

2) Switch setting

NO	Parameter	Range(<i>default</i>)	Notes
1	Close Time	1-20S(5S)	Pulse time of close relay
2	Open Time	1-20S(5S)	Pulse time of open relay
3	Transfer Interval	0-9999(1S)	Interval time from S1 switch open to S2 switch close; or from S2 switch open to S1 switch close.
4	Again Close Delay	0-20S(1S)	When the breaker fail to open for the first time, then the module will close for the second time and the Again Close Delay begins, after the delay has expired, if still failed to open for the second time, the module will send out fail to open alarm.
5	Again Open Delay	0-20S(1S)	When the breaker fail to close for the first time, then the module will open for the second time and the Again Open Delay begins, after the delay has expired, if still failed to close for the second time, the module will send out fail to close alarm.
6	Switch Type	0: CB/CC 1: PC Three-stage 2: PC Two-stage	0: Use S1 Open and S2 Open to control 1: PC switch with OFF position, use S1 Open to control 2: PC switch without OFF position
7	Forced Open Action	0: Warn Alarm 1: Fault Alarm	Forced breaking function
8	Continuously Close	0: Disable 1: Enable	If "Enable" is selected, "Close Time" and "Open Time" are deactivated.
9	ATS Power Type	0: DC Power; 1: AC Power	Switch power supply type selection.
10	ATS Power Low Point	0-100% (70%)	Lower limit voltage of switch power; The switch can not transfer when the value has fallen below the set value.
11	ATS Power High Point	0-200% (130%)	Upper limit voltage of switch power; The switch can not transfer when the value has exceeded the set value.

3) Generator setting

NO	Parameter	Range(<i>defaults</i>)	Notes
1	Gen Start Delay	0-9999S(1S)	When the genset is ready to start, start delay begins, after the start delay has expired, start signal will be initiated.
2	Gen Stop Delay	0-9999S(5S)	When the genset is ready to stop, stop delay begins, after the stop delay has expired, stop signal will be initiated.
3	Gen-Gen Start Mode	0: Cycles Gens 1: Master-Slave	Generator start mode.

		Gens 2: Balance Gens Hours	
4	S1 Cycles Work Time	0-9999Min(720Min)	Gens cycle start S1 running time.
5	S2 Cycles Work Time	0-9999Min(720Min)	Gens cycle start S2 running time.
6	Genset Available Time	0-9999S(120S)	When the start signal is active, the start delay will be initiated. If the gen voltage lasts abnormal after the delay has expired, "Genset Fault" alarm will be initiated.(S1 Gen S2 Gen valid)
7	Battery Under Volt Set Value	0-100V(10V)	"Battery Under Volts" alarm will be initiated if the battery voltage has fallen below the set value.
8	Battery Under Volt Return Value	0-100V(10.5V)	"Battery Under Volts" alarm will be removed if the battery voltage has exceeded the set value.
9	Battery Over Volt Set Value	0-100V(30V)	"Battery Over Volts" alarm will be initiated if the battery voltage has exceeded the set value.
10	Battery Over Volt Return Value	0-100V(29.5V)	"Battery Over Volts" alarm will be removed if the battery voltage has fallen below the set value.

4)Input/Output setting

No	Parameter	Range(defaults)	Notes
1	AUX.INPUT 1	0-25(2:Remote start on Load:)	<p>0: Disable: Disable this digital function</p> <p>1: Forced Open: No matter the genset is in manual mode or Auto mode, when the input is active, this will force the breaker to transfer the ATS to OFF position. "No Breaking" ATS is unavailable.</p> <p>2: Remote start on Load: When the mains power is normal, the generator set will start to output and the generator will close.</p> <p>3: Remote start Off Load: When the mains power is normal, the generator set starts to output and the power generation is not closed.</p> <p>4: S1 Fault Input: When the unit is turned on cyclically, the unit fails and cannot be started.</p> <p>5: S2 Fault Input: When the unit is turned on cyclically, the unit fails and cannot be started.</p> <p>6: Breaker Trip Input: Switch trip fault input.</p> <p>7: S1 Master Input: Force S1 to be active.</p> <p>8: S2 Master Input: Force S2 to be active.</p> <p>9:Test lamp: LED indicators on the panel are all on; LCD backlight is on; LCD screen is dark;</p> <p>10-25: Reserved</p>
3	AUX.INPUT 2	0-25(1:Forced Open)	
9	AUX.OUTPUT 1	0-40(11: Gens)	

		<i>Start Output)</i>	
11	AUX.OUTPUT 2	0-40(20: ATS Power L)	<p>1: Common Alarm: Output when the unit has any alarm, until the alarm is reset.</p> <p>2: Common Fault Alarm: Output when the unit has any fault alarm, the controller will open until the alarm resets.</p> <p>3: Common Warn Alarm: It is output when the unit has any warning alarm, until the alarm is reset.</p> <p>4: Transition Fault: It includes S1 Fail to Close alarm, S1 Fail to Open alarm, S2 Fail to Close alarm, S2 Fail to Open alarm.</p> <p>5: S1 Available: Output when S1 power is normal.</p> <p>6: S1 Unavailable: Output when S1 power supply is abnormal.</p> <p>7: S2 Available: Output when S2 power is normal.</p> <p>8: S2 Unavailable: Output when S1 power supply is abnormal.</p> <p>9: Manual Mode: Output when the genset is in Manual mode.</p> <p>10: Auto Mode: Output when the genset is in Auto mode.</p> <p>11: Gens Start Output: Control the genset to start.</p> <p>12: S1 Close Control: Control the S1 switch to close.</p> <p>13: S1 Open Control: Control the S1 switch to open. If PC Three-stage is selected, it also Control the S2 switch to open.</p> <p>14: S2 Close Control: Control the S2 switch to close.</p> <p>15: S2 Open Control: Control the S2 switch to open.</p> <p>16: Breaker1 On Feedback: The close status of S1 switch.</p> <p>17: Breaker2 On Feedback: The close status of S2 switch.</p> <p>18:S1 Genset Start: When the system type is "S1 Gen S2 Gen", it controls the S1 genset start.</p> <p>19:S2 Genset Start: When the system type is "S1 Gen S2 Gen", it controls the S2 genset start.</p> <p>20: ATS Power L1: 25-30 ATS power status output. Refer to the related description of ATS power supply "Switch operation and ATS power control" in the catalog".</p> <p>21: ATS Power L2</p> <p>22: ATS Power L3</p> <p>23: ATS Power N</p>
13	AUX.OUTPUT 3	0-40(23: ATS Power N)	

			24: S1/S2 Abnormal Volt: It outputs when S1 voltage and S2 voltage are abnormal. 25: Maintenance and startup: Timing test function starts; 26: Battery Under Volt: Output when battery is under voltage. 27: Battery Over Volt: Output when battery is over voltage. 28-40: Reserved
10	AUX.OUTPUT 1 Active Type	0: Normally open 1: Normally close	Set the state when the relay output is active
12	AUX.OUTPUT 2 Active Type	0: Normally open 1: Normally close	
14	AUX.OUTPUT 3 Active Type	0: Normally open 1: Normally close	

5)Module setting

No	Parameter	Range(default)	Notes
1	Primary Modes	0: Manual 1: Auto 2: Previous Mode	The primary modes on power, easy for user operation.
2	Controller ID	1-255(16)	The IP built by controller and PC.
3	User password	00000-65535(07623)	Change the password.
4	RS485 baud rate	0-4800 1-9600 2-19200	RS485 communication baud rate.
5	Stop Bit	1 2	2 stop bits or 1 stop bit can be set.
6	Current Year/Month/Date	2016/01/01-2099/12/31	Permanent calendar inside, please correct the date timely.
7	Current time	00:00:00-23:59:59	Permanent calendar inside, please correct the time timely.
8	Start screen display	0-20.0s (5.0s)	Start screen display time,0: No-display.
9	Saving mode	5.0-6000.0s (600.0s)	LCD light will be closed automatically without any button pressed after delay. If setting as 6000.0s, back light always lighted.
10	Homing display	5.0-600.0s (600.0s)	The time when the page reverts back to the home page, If setting as 600.0s: disabled.
11	LOGO delay display under standby	5.0-6000.0(6000.0s)	Start screen will be opened without any button pressed after delay, If setting as 6000.0s: disabled.
12	LCD contrast	50-127(106)	Set the LCD display contrast.

6)Working and maintenance setting

No	Parameter	Range(defaults)	Notes
1	Working plan format	Disable Every month Every week	This mode must be under auto mode. Working plan is disabled once setting as disable. The working plan will be executed according the

			chosen date when setting as every month. The working plan will be executed according to the chosen date when setting as every week.
2	Maintenance date per month	From 1 st to 31 st Default: the first day	The date chosen for every month.
3	Maintenance date per week	Monday to Sunday Default: Sunday	The date chosen for every week.
4	Maintenance with load or not	Disabled /with load	To choose if the genset starts with load or not.
5	Maintenance start time	00:00-23:59(00:00)	Maintenance start time setting.
6	Maintenance running time	1-120m(5m)	Maintenance running time setting.

Fault finding

Symptoms	Possible Solutions
Controller no response with power	Check DC voltage. Check DC fuse. Check AC Power supply.
Genset Start Abnormal	Check the system type setting; Check the output port function type and output settings; Check various start / stop function settings
Genset running while ATS not transfer	Check switch Check the connection between the controller and the switch; Check whether the switch type setting is consistent with the switch; Check ATS power settings and wiring
Auxiliary Output Error	Check auxiliary output connections, pay attention to normally open contact and normally close contact. Check the output settings in parameters settings.
Auxiliary Input Abnormal	Check whether the programmable input port is reliably grounded when the input is valid, and it should be left floating when the input is invalid (Note: If the input port is connected to an excessively high voltage, it may burn the input port); Input port setting function and input valid type in detection parameter setting
USB communication is abnormal	Check the USB connection. Check whether the USB port of the computer is normal. Check whether the USB driver is installed. Check whether the controller is normally powered on.
RS485 cannot communicate normally	Check the connection. Check if the communication ID number setting is correct. Check if the A and B lines of RS485 are reversed. Check if the RS485 communication line driver is installed or not. Check if the communication port of the PC is damaged. Add a 120 Ω resistor between the AB of the controller RS485.